

**Multiple Connectors**

- Snap-in Plugs
- Wire Leads
- DIN Connector
- Spade Terminals
- Custom Plugs

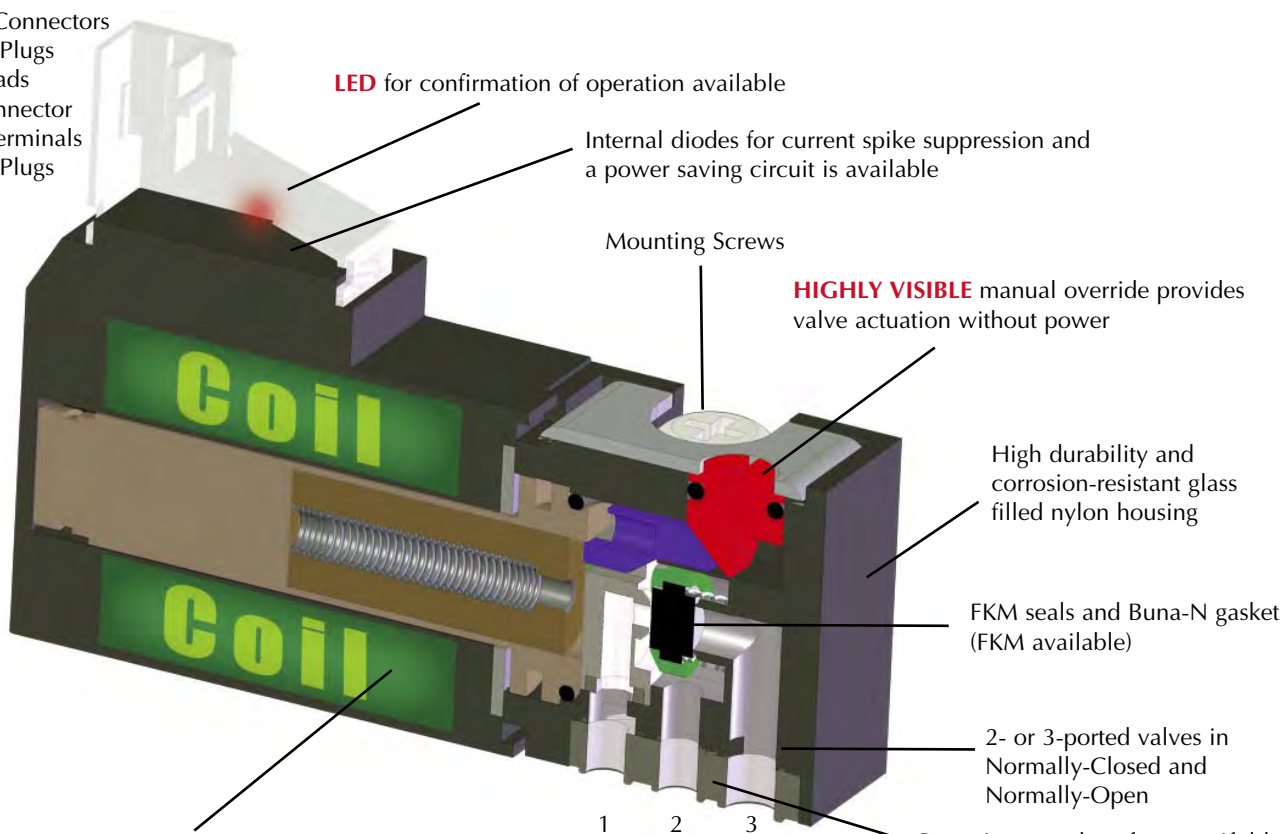

Encapsulated low wattage coils. Available in: 12 VDC, 24 VDC, 24 VAC, 110 VAC or 220 VAC. Special voltages available for OEMs.

Configuration	1	2	3
N.C. & N.O.	exhaust	outlet	supply

One-piece gasket for manifold mounted and supply/exhaust port reversed for same manifold mounting of N.O. or N.C. valve

## Functional Schematics

### Normally-Closed 3-Way Valve

**S** - Supply  
**E** - Exhaust  
**O** - Outlet

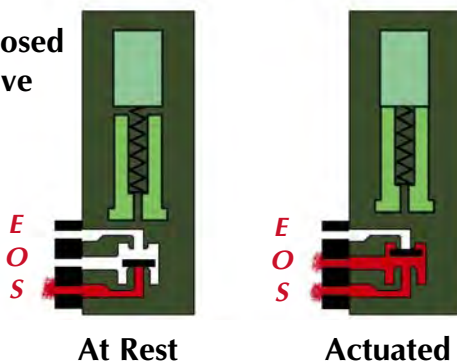

### Normally-Open 3-Way Valve

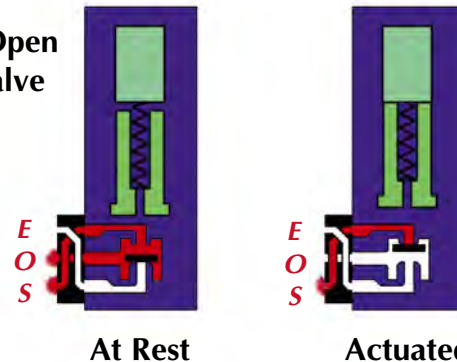

**Porting Gasket**  
The Normally-Open and Normally-Closed configurations allow both models to be mounted on the same manifold.

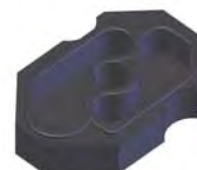



# 15 MM MINIATURE VALVES

## Specifications

**Medium:** Air, Gas, or other Compatible Fluids

**Working Pressure:** See Chart below.

**Maximum Flow Rate:**  
 0.032" (0.8 mm) Orifice: 45 l/min (1.6 scfm)  
 0.043" (1.1 mm) Orifice: 70 l/min (2.6 scfm)  
 0.063" (1.6 mm) Orifice: 91 l/min (3.2 scfm)

**Response Time:** 10 ms when energized; 12 ms when de-energized



**Material:** Stainless steel core and springs, springs, nylon body, FKM seals, and Buna-N gasket. FKM gasket available, consult factory

**Voltage:** 12-volt DC, 24-volt DC or 24-volt AC. 110-volt AC and 220-volt AC only available with DIN Connectors.

**Voltage Tolerance:** -5% to 10%

**Power Consumption:** 1.0 or 2.5 watts dependent on orifice size and pressure

**Coil Insulation Class:** F 311°F (155°C)

**Temperature Range:** 23 to 122°F (-5 to 50°C)

## Order Information

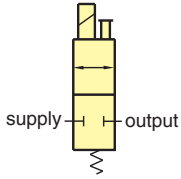
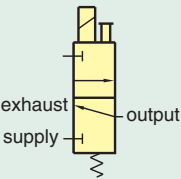
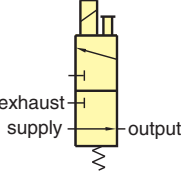
Type	Base No.	Connector	12	24	24	110	220	Orifice	Wattage	Working Pressure
			VDC	VDC	VAC	VAC	VAC			
<b>2/2 Normally-Closed</b> 	E215D-1T*	Terminal	•	•				0.032"	1.0	0 to 150 psig/10.3 bar
	E215E-2T*		•	•	•			0.043"	2.5	0 to 150 psig/10.3 bar
	E215F-2T*		•	•	•			0.063"	2.5	0 to 110 psig/7.6 bar
	E215D-1D*	DIN Connector	•	•				0.032"	1.0	0 to 150 psig/10.3 bar
	E215E-2D*		•	•	•	•		0.043"	2.5	0 to 150 psig/10.3 bar
	E215F-2D*		•	•	•	•		0.063"	2.5	0 to 110 psig/7.6 bar
	E215D-1W*	Wire Leads, 11.8" (300 mm)	•	•				0.032"	1.0	0 to 150 psig/10.3 bar
	E215E-2W*		•	•	•			0.043"	2.5	0 to 150 psig/10.3 bar
	E215F-2W*		•	•	•			0.063"	2.5	0 to 110 psig/7.6 bar
	E215D-1L*	90° Connector with LED	•	•				0.032"	1.0	0 to 150 psig/10.3 bar
E215E-2L*	•		•				0.043"	2.5	0 to 150 psig/10.3 bar	
E215F-2L*	•		•				0.063"	2.5	0 to 110 psig/7.6 bar	
E215D-1C*	In-Line Connector with LED	•	•				0.032"	1.0	0 to 150 psig/10.3 bar	
E215E-2C*		•	•				0.043"	2.5	0 to 150 psig/10.3 bar	
E215F-2C*		•	•				0.063"	2.5	0 to 110 psig/7.6 bar	
<b>3/2 Normally-Closed</b> 	E315D-1T*	Terminal	•	•				0.032"	1.0	0 to 150 psig/10.3 bar
	E315E-2T*		•	•	•			0.043"	2.5	0 to 150 psig/10.3 bar
	E315F-2T*		•	•	•			0.063"	2.5	0 to 110 psig/7.6 bar
	E315D-1D*	DIN Connector	•	•				0.032"	1.0	0 to 150 psig/10.3 bar
	E315E-2D*		•	•	•	•		0.043"	2.5	0 to 150 psig/10.3 bar
	E315F-2D*		•	•	•	•		0.063"	2.5	0 to 110 psig/7.6 bar
	E315D-1W*	Wire Leads, 11.8" (300 mm)	•	•				0.032"	1.0	0 to 150 psig/10.3 bar
	E315E-2W*		•	•	•			0.043"	2.5	0 to 150 psig/10.3 bar
	E315F-2W*		•	•	•			0.063"	2.5	0 to 110 psig/7.6 bar
	E315D-1L*	90° Connector with LED	•	•				0.032"	1.0	0 to 150 psig/10.3 bar
E315E-2L*	•		•				0.043"	2.5	0 to 150 psig/10.3 bar	
E315F-2L*	•		•				0.063"	2.5	0 to 110 psig/7.6 bar	
E315D-1C*	In-Line Connector with LED	•	•				0.032"	1.0	0 to 150 psig/10.3 bar	
E315E-2C*		•	•				0.063"	2.5	0 to 150 psig/10.3 bar	
E315F-2C*		•	•				0.063"	2.5	0 to 110 psig/7.6 bar	
<b>3/2 Normally-Open (110 psig max.)</b> 	E3O15E-2T*	Terminal	•	•	•			0.043"	2.5	0 to 110 psig/7.6 bar
	E3O15F-2T*		•	•	•			0.063"	2.5	0 to 75 psig/5.2 bar
	E3O15E-2D*	DIN Connector	•	•	•	•	•	0.043"	2.5	0 to 110 psig/7.6 bar
	E3O15F-2D*		•	•	•	•	•	0.063"	2.5	0 to 75 psig/5.2 bar
	E3O15E-2W*	Wire Leads, 11.8" (300 mm)	•	•	•			0.043"	2.5	0 to 110 psig/7.6 bar
	E3O15F-2W*		•	•	•			0.063"	2.5	0 to 75 psig/5.2 bar
	E3O15E-2L*	90° Connector with LED	•	•				0.043"	2.5	0 to 110 psig/7.6 bar
	E3O15F-2L*		•	•				0.063"	2.5	0 to 75 psig/5.2 bar
E3O15E-2C*	In-Line Connector with LED	•	•				0.063"	2.5	0 to 110 psig/7.6 bar	
E3O15F-2C*		•	•				0.063"	2.5	0 to 75 psig/5.2 bar	

• Indicates standard items

\* Add Voltage Choice to the end of each Base Part Number. "012" (12 VDC), "024" (24 VDC) "24A" (24 VAC), "110" (110 VAC) or "220" (220 VAC). Example: **E315D-1C012**

# 15 MM MINIATURE VALVES



## Terminal Connector



Industrial Form C Connector ordered separately below.

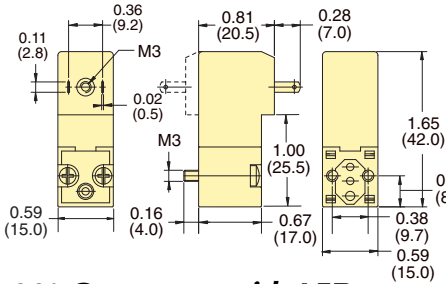

## DIN Connector

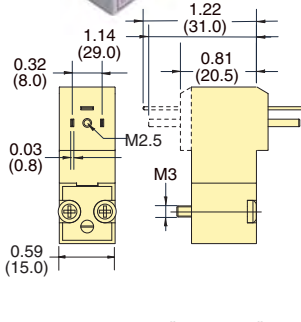

## In-Line Connector with LED

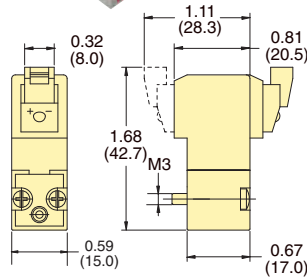

## Wire Leads



DIN Connector ordered separately below.

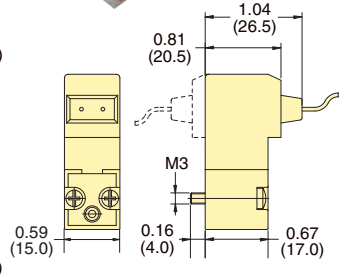

## 90° Connector with LED

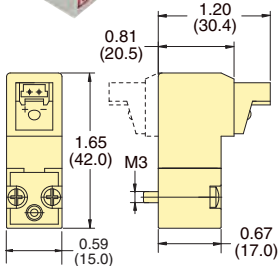

## Typical Air Flow

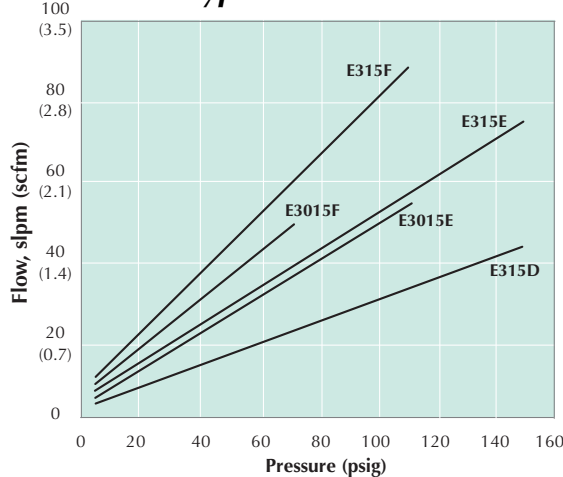

## Mounting Interface

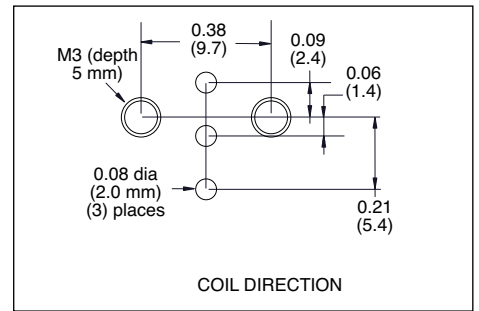

## DIN Connectors

### For Use with 15 mm Valves Only

DIN 43650 Form C Connectors with 8 mm spade center spacing mate with the 15 mm DIN connector coil. Industrial Form Connectors with 9.4 mm spade center spacing are designed to connect to 15 mm terminal coils. Both are available with or without surge suppression, and 152 or 381 mm PVC molded three-wire cord set.

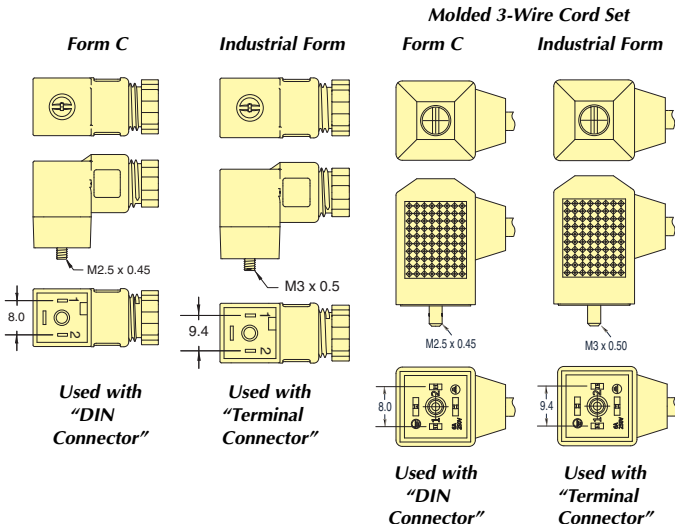

Form C Part No.	Industrial Form Part No.	Volts	LED	Cord
CC-C	CC-I	6-240	no	-
CC-C-P6	CC-I-P6	6-240	no	6'
CC-C-P15	CC-I-P15	6-240	no	15'
CC-CLL	CC-ILL	6-24	yes	-
CC-CLL-P6	CC-ILL-P6	6-24	yes	6'
CC-CLL-P15	CC-ILL-P15	6-24	yes	15'
CC-CLM	CC-ILM	48-110	yes	-
CC-CLM-P6	CC-ILM-P6	48-110	yes	6'
CC-CLM-P15	CC-ILM-P15	48-110	yes	15'



# LATCHING 15 MM MINIATURE VALVES



- 2-Way & 3-Way Normally-Closed configurations
- Pulse-actuated (on or off)
- 3-wire coil. No polarity reverse required
- Stable latch

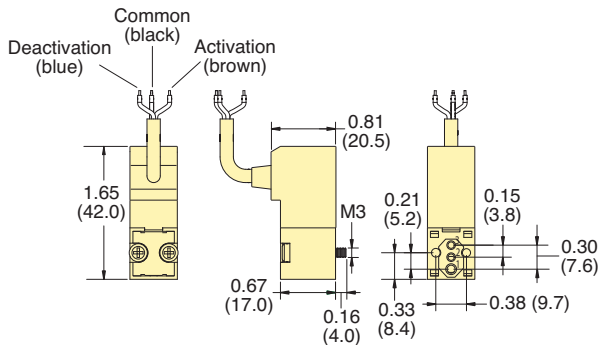

**Response Time:** 10 ms when energized; 12 ms when de-energized

**Copper Wire Isolation Class:** F 311°F (155°C)

**Material:** Stainless steel core and springs, nylon body, FKM dynamic seals, and Buna-N gasket and static seals. FKM gasket available, consult factory.

**Temperature Range:** 23 to 122°F (-5 to 50°C). When below 32°F (0°C), must use clean, dry air

## Mounting Interface

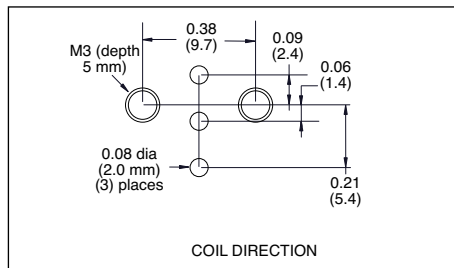

Clippard's 15 mm Latching Valves have many of the same features as the popular 15 mm standard valve line including small, compact design, exceptional life and reliability, light-weight design and more. A careful balance of forces—through the precise placement of a permanent magnet in the valve core—produces a bi-stable valve. A short pulse of current opens the valve, which “latches” open indefinitely after the current stops. A subsequent pulse of current in the opposite direction closes the valve. The valve consumes less energy and produces less heat than a standard solenoid valve when used in extended duty cycle applications, since the coil is energized for only a small fraction of the total duty cycle.

**Medium:** Air, Gas or other Compatible Fluids

**Max. Flow Rate:** 0.043" (1.1 mm) Orifice: 59 l/min (2.1 scfm)  
0.063" (1.6 mm) Orifice: 84 l/min (3.0 scfm)

**Electrical Connection:** 3-Wire Molded Cord, 300 mm, 24 AWG 4.5 mm external jacket; tinned copper wires; silicone jacket and conductor insulation

**Electrical:** 12 VDC (“-012”) or 24 VDC (“-024”). 6 VDC also available. Call for further information.

**Electrical Tolerance:** -5 to 10%

## Typical Air Flow

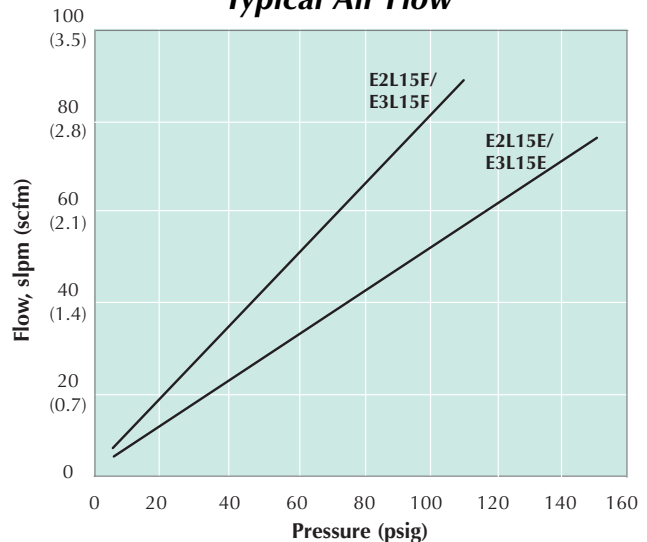

Type	Part No.	Connector	Orifice	Voltage	Wattage	Pressure Range
2-Way	<a href="#">E2L15E-4W012</a>	3-Wire Molded Cord, 300 mm	0.043" (1.1 mm)	12 VDC	4.0	0 to 150 psig/10.3 bar
	<a href="#">E2L15E-4W024</a>		0.043" (1.1 mm)	24 VDC		0 to 150 psig/10.3 bar
	<a href="#">E2L15F-4W012</a>		0.063" (1.6 mm)	12 VDC		0 to 110 psig/7.6 bar
	<a href="#">E2L15F-4W024</a>		0.063" (1.6 mm)	24 VDC		0 to 110 psig/7.6 bar
3-Way	<a href="#">E3L15E-4W012</a>	3-Wire Molded Cord, 300 mm	0.043" (1.1 mm)	12 VDC	4.0	0 to 150 psig/10.3 bar
	<a href="#">E3L15E-4W024</a>		0.043" (1.1 mm)	24 VDC		0 to 150 psig/10.3 bar
	<a href="#">E3L15F-4W012</a>		0.063" (1.6 mm)	12 VDC		0 to 110 psig/7.6 bar
	<a href="#">E3L15F-4W024</a>		0.063" (1.6 mm)	24 VDC		0 to 110 psig/7.6 bar

See [page 214](#) for connectors and manifolds

## Specifications

**Medium:** Air, Gas, or other Compatible Fluids

**Working Pressure:** 0 to 43 psig/3.0 bar

**Maximum Flow Rate:** 120 l/min (4.3 scfm)

**Orifice:** 0.118" (3.0 mm)

**Material:** Stainless steel core and springs, nylon body, FKM seals, and Buna-N gasket. FKM gasket available, consult factory

**Response Time:** 10 ms when energized; 12 ms when de-energized

**Voltage:** 12-volt DC or 24-volt DC

**Voltage Tolerance:** -5% to 10%

**Power Consumption:** 4.0 watts

**Coil Insulation Class:** F 311°F (155°C)

**Temperature Range:** 23 to 122°F (-5 to 50°C)

### 90° Connector with LED

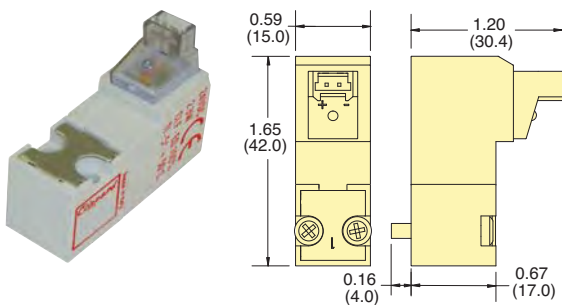

### In-Line Connector with LED

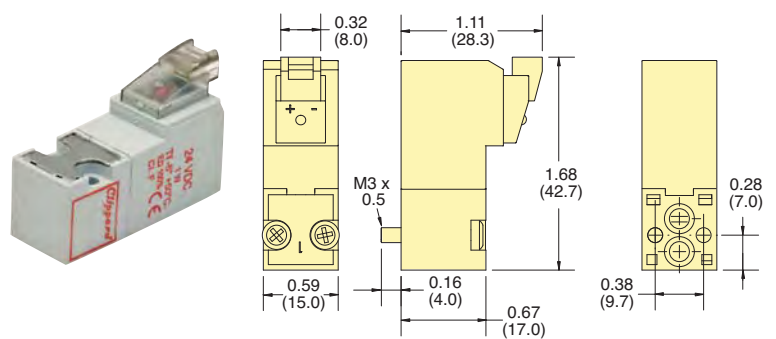

Part No.	Connector	Voltage
<a href="#">E215H-3L012</a>	90° Connector	12 VDC
<a href="#">E215H-3L024</a>	with LED	24 VDC
<a href="#">E215H-3C012</a>	In-Line Connector	12 VDC
<a href="#">E215H-3C024</a>	with LED	24 VDC

### Typical Air Flow

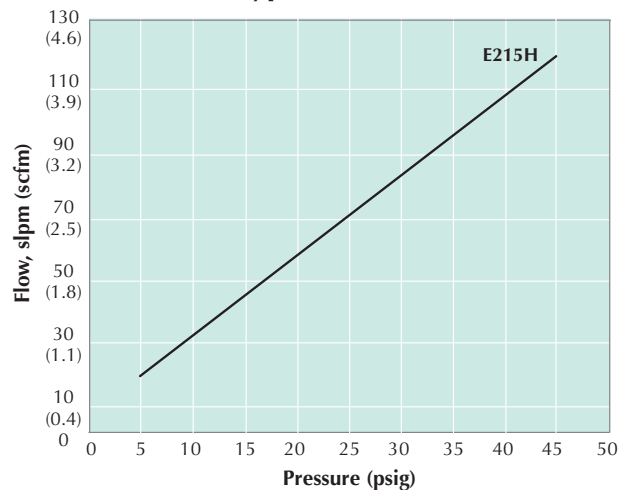

### Mounting Interface

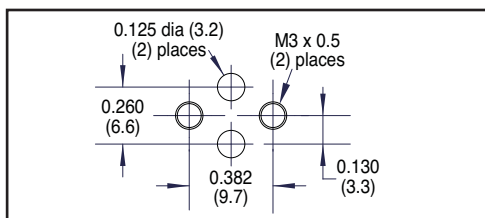

### 15 mm High Flow Single-Station Manifold

Spare hardware and closing plates available. Add -M5 for metric ports.

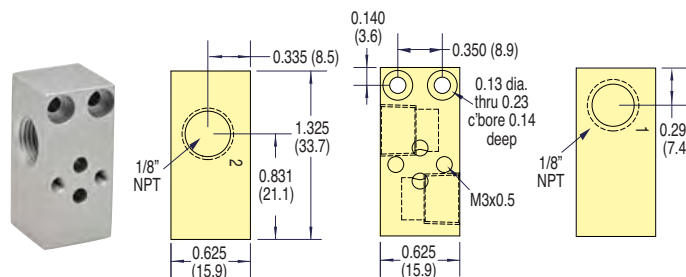

**Part No.**  
[E15HM-01](#) 15 mm Single-Station Manifold

### Functional Schematics

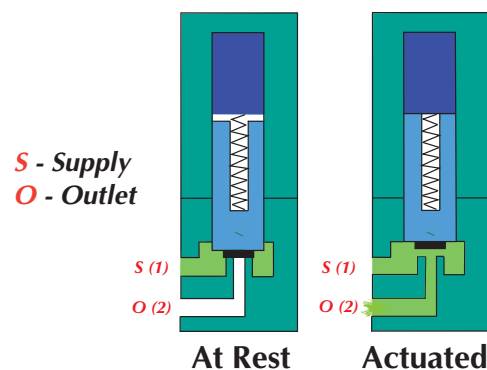



# 15 MM VALVE ACCESSORIES

## Sub-Miniature Manifolds

Small, compact manifolds offer the efficient grouping of 15 mm valves along with fast installation. Each manifold features a common inlet, individually-ported outlets, and exhaust to atmosphere.

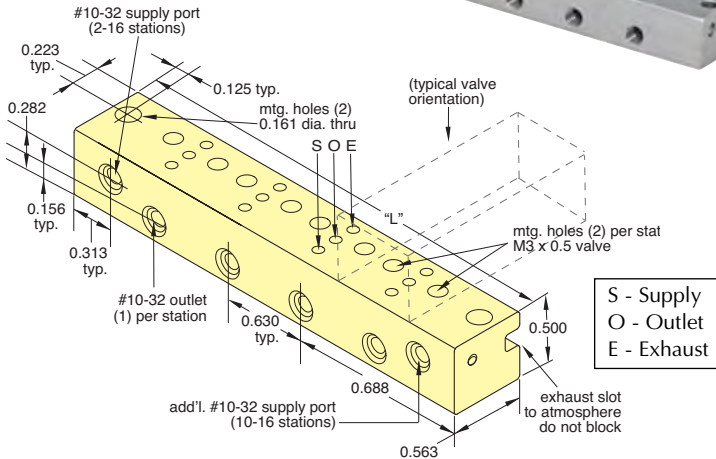
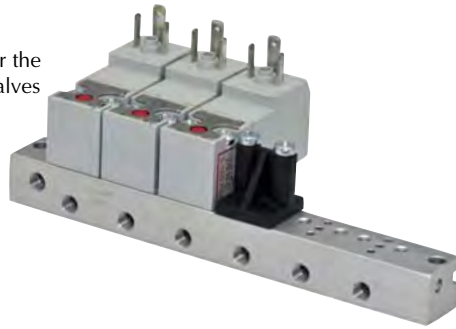

Stations	Supply Ports	Part No.	Length "L"
2	1	<a href="#">E15SM-2</a>	2.01 (51.1)
4	1	<a href="#">E15SM-4</a>	3.27 (83.1)
6	1	<a href="#">E15SM-6</a>	4.53 (115.1)
8	1	<a href="#">E15SM-8</a>	5.79 (147.1)
10	2	<a href="#">E15SM-10</a>	7.05 (179.1)
12	2	<a href="#">E15SM-12</a>	8.31 (211.1)
14	2	<a href="#">E15SM-14</a>	9.57 (243.1)
16	2	<a href="#">E15SM-16</a>	10.82 (274.8)



## Connectors

Wire Connector must be ordered separately. 24 AWG. Stranding 7/32.

### Part No.

- [C2A-RB300](#) Connector with Cable, 11.8" (300 mm)
- [C2A-RB500](#) Connector with Cable, 19.69" (500 mm)
- [C2A-RB1000](#) Connector with Cable, 39.37" (1,000 mm)

Molex terminal insert #050013-8000, #28139 plug and 24 AWG wire.

## Cover Plate

Manifold Cover Plate includes plate, gasket and two screws.

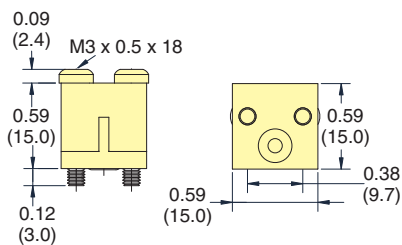

### Part No.

- [E15M-CP](#) 15 mm Cover Plate

## Standard Manifolds

Standard manifolds are available for one to 16 valves with ported exhaust. Spare hardware and closing plates also available. Add -M5 for metric ports.

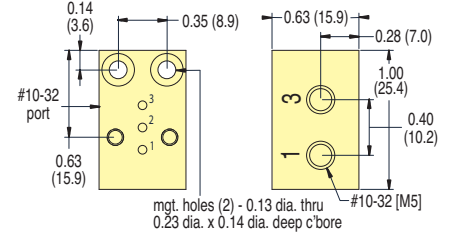

### Part No.

- [E15M-01](#) Single-Station Manifold

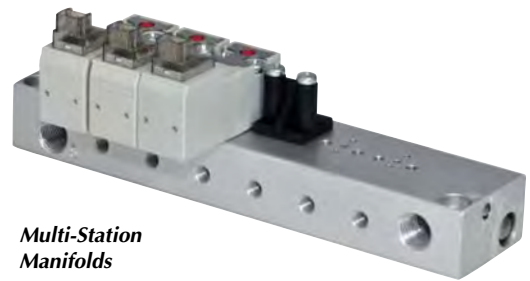

### Multi-Station Manifolds

#### 2- through 8-Station

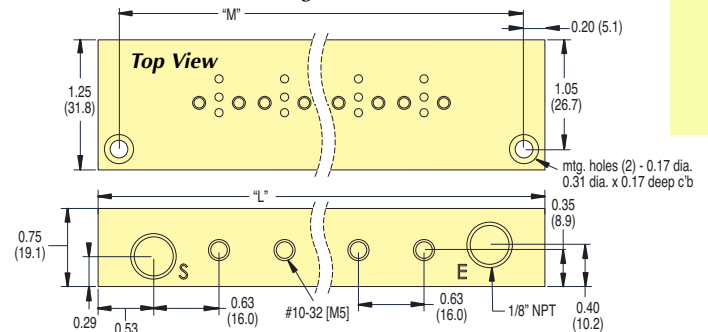

#### 10- through 16-Station

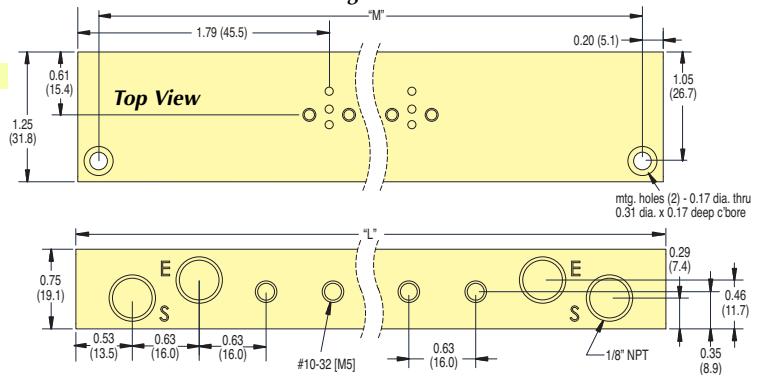

Stations	Part No.	Length "L"	Length "M"
2	<a href="#">E15M-02</a>	2.95 (74.2)	2.55 (64.8)
4	<a href="#">E15M-04</a>	4.21 (106.9)	3.81 (96.8)
6	<a href="#">E15M-06</a>	5.47 (138.9)	5.07 (128.8)
8	<a href="#">E15M-08</a>	6.73 (170.9)	6.33 (160.8)
10	<a href="#">E15M-10</a>	9.25 (235.0)	8.85 (224.8)
12	<a href="#">E15M-12</a>	10.51 (277.0)	10.1 (256.8)
14	<a href="#">E15M-14</a>	11.77 (299.0)	11.4 (288.8)
16	<a href="#">E15M-16</a>	13.03 (331.0)	12.6 (320.0)